

# GM116

## WALL FIXTURE

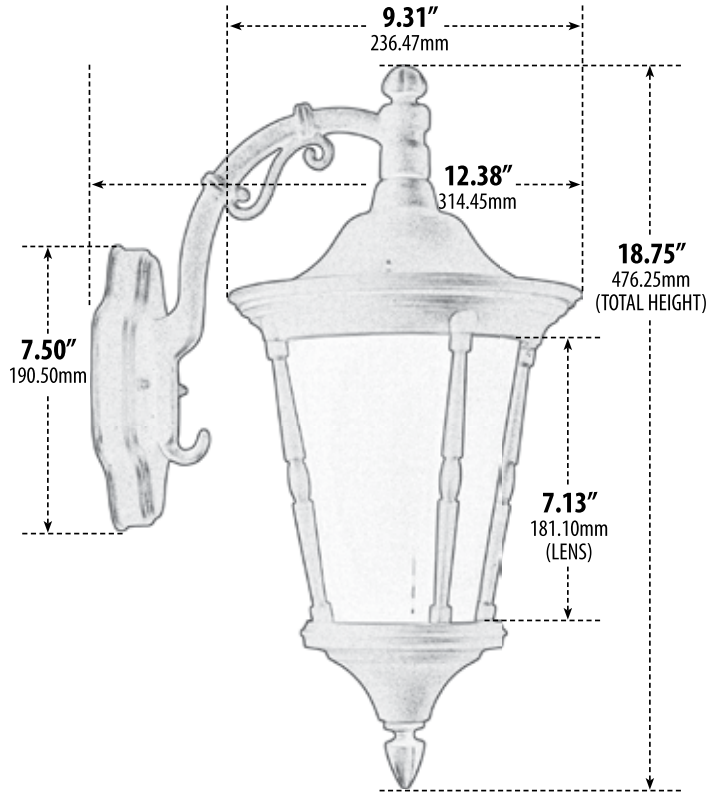

- ▶ **Material:** Powder Coated Cast Aluminum
- ▶ **Lens:** Acrylic
- ▶ **Available Finish:** Black, White, Verde Green
- ▶ **ETL Approved**

MODEL NUMBER	LAMP TYPE	ILLUMINANT TYPE	WATTS (W)	VOLTS (V)	LAMP(S) INCLUDED?
GM116**	A-Type	Incandescent	60	120	NO
GM111	S13-GU24	Fluorescent	13	120	YES
GM119	S26-GU24	Fluorescent	26	120	YES

\*\*AVAILABLE IN 11W LED Add -LED11 to Model Number

\*\*AVAILABLE IN 20W LED Add -LED20 to Model Number

Overall Dimensions:  
18.75"H x 9.31"W x 12.38"D

Weight: 3.8 lbs

Approx. Wire Length: 11"

Box Dimensions:

16.13"H x 12.38"W x 9.38"D

**DABMAR**  
LIGHTING

DABMAR LIGHTING INCORPORATED

2140 Eastman Ave . Oxnard, CA 93030 . 805.604.9090 . f: 805.604.9050 . www.dabmar.com