



KALCO.
Handcrafted Since 1980

ASSEMBLY & INSTALLATION INSTRUCTIONS

MODEL: 4203
AMERICANA 3 LIGHT BATH

I M A G E



If you have any questions or problems assembling your fixture please call us for assistance.

Customer Service: (702) 361-4345 or (800) 525-2655
customer.services@kalco.com

WARNING! TO REDUCE THE RISK OF FIRE OR INJURY PLEASE TAKE PRECAUTION AND FOLLOW THE STEPS BELOW.

1. If you are unfamiliar with electrical wiring, call a qualified electrician to install this unit. More than one person may be necessary to install fixture, make sure you have enough qualified help.
2. Turn off the power to the fixture's circuit at the service panel. Use a voltage detector to verify that the power is off.
3. DO NOT install bulb which exceeds the maximum wattage specified on the socket label.

Si vous avez des questions ou des problèmes assemblage de votre dispositif s'il vous plaît appel pour l'assistance.

Customer Service: (702) 361-4345 or (800) 525-2655
customer.services@kalco.com

AVERTISSEMENT! POUR RÉDUIRE LES RISQUES D'INCENDIE OU DE BLESSURES S'IL VOUS PLAÎT PRENDRE DES PRÉCAUTIONS ET SUIVEZ LES ÉTAPES CI-DESSOUS.

1. Si vous n'êtes pas familier avec le câblage électrique, appelez un électricien qualifié pour installer cet appareil. Plus d'une personne peut être nécessaire d'installer appareil, assurez vous que vous disposez de l'aide assez qualifié.
2. Coupez l'alimentation au circuit de l'appareil sur le tableau de service. Utiliser un détecteur de tension pour vérifier que l'alimentation est coupée
3. NE PAS installer l'ampoule qui excède la puissance maximale indiquée sur l'étiquette du socket.

WIRING DIAGRAM

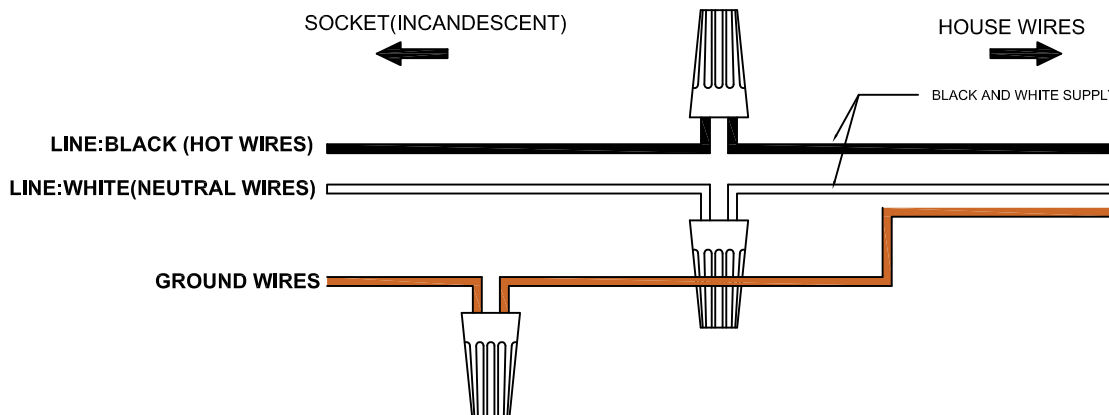

ASSEMBLY & INSTALLATION INSTRUCTIONS

MODEL: 4203
AMERICANA 3 LIGHT BATH

MOUNTING INSTRUCTIONS

- STEP 1:** Fasten (2) 8-32 x 1 1/2" studs into mounting plate so that they extend away from the ceiling when the mounting plate is installed.
- STEP 2:** Attach mounting plate to outlet box with the (2) 8-32 x 3/4" screws.
- STEP 3:** Refer to wiring diagram. With wire carefully threaded thru canopy, connect the black supply wire to the black fixture wire with wire connector, connect the white supply wire to the white fixture wire with wire connector. Connect ground wire from fixture with supply ground wire.
- STEP 4:** Carefully tuck all wires into outlet box ensuring that there are no wires pinched between the canopy and wall.
- STEP 5:** Attach the back plate to mounting plated and lock it by using two (2) pcs. of ball nut.

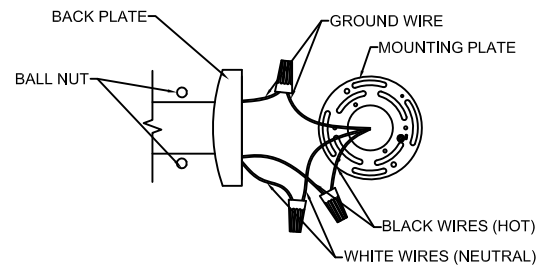
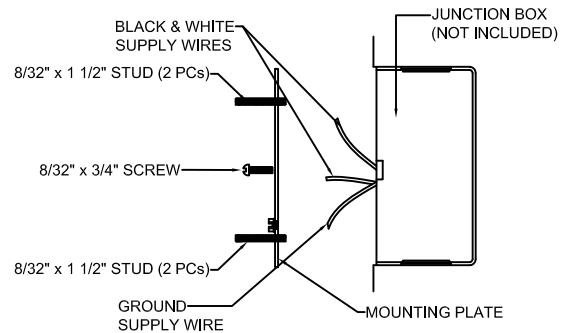

FRAME/COMPONENTS ASSEMBLY

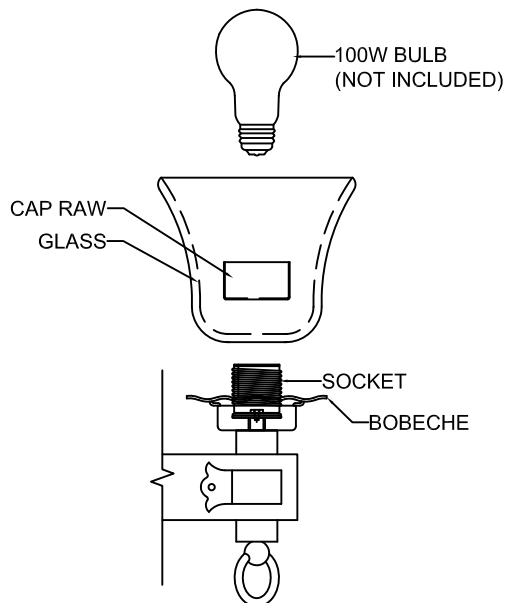

STEP 6: Insert the glass and secure with cap raw.

STEP 7: Install bulb, do not use bulbs that exceeds 100W.

LIGHTING MAINTENANCE:

- Regular cleaning of fixture with proper and gentle care using a soft duster, soft lint-free or damp cloth is recommended.
- Refrain from using harsh cleaning liquids that may cause chemical reaction on the hand painted finishes.
- Always refer to the Assembly Instruction before removing any components.
- **HANDLE WITH CARE.**







KALCO.
Handcrafted Since 1980

ASSEMBLY & INSTALLATION INSTRUCTIONS

MODEL: 4203
AMERICANA 3 LIGHT BATH

PARTS LIST

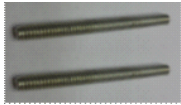
IMAGE	PARTS NAME	QTY
	X2-A Parts Bag	1 PC
	Screw	2 PCs
	Ball Nut	2 PCs
	Hex Nut	2 PCs
	Stud	2 PCs